Volt/VAr Optimization of Distribution System with Integrated Distributed Generation

MARIAM MUGHEES*, FAHIM GOHARAWAN**, AND ANAM MUGHEES*

RECEIVED ON 21.03.2016 ACCEPTED ON 11.05.2016

ABSTRACT

This paper addresses the issues of VVO (Volt/VAr Optimization) such as loss minimization, acceptable voltage profiles and optimized number of switching operations. Basic function of the DMS (Distribution Management System) is to upgrade system intelligence so that it can make dynamic decisions and control the network in realtime. Distributed generators can cause the system to operate above and below the desired limits due to their variable nature. Therefore, devices like SC (Shunt Capacitors) and OLTC (On Load Tap Changers) are used in distribution system as control devices. Main focus of this paper is to inspect effects of DG (Distributed Generation) on switching states of control devices while considering Volt/VAr standards. An optimization search algorithm is employed to search the optimal solution considering the system constraints. The GA (Genetic Algorithm) is used for the optimization process of the system and the simulation is done in MATLAB using IEEE-30 bus system with DG under 24 hour changing load profiles. By setting up constraints of distribution system's voltage limits, capacitor bank and OLTC, losses are minimized up to 50%. Merits of the proposed optimized method are demonstrated through simulation results. The result achieved from the proposed technique has proven to be beneficial for switching optimization of control devices under variant conditions of loads and distributed generation.

Key Words: Volt/VAr Optimization, Distributed Generation, Shunt Capacitor, On Load Tap Changer, Genetic Algorithm, Distribution Management System.

1. INTRODUCTION

DMS is a platform for controlling, monitoring, fault allocation and restoration for distribution system. Volt/VAr control is one of the crucial functions of DMS in changing environment, which includes DG and smart grid trends. DGs are vast sources of energy, profitable for both customers and utilities therefore it is necessary to accommodate DGs with maximum profit in system. It is necessary to implement some optimization method for reducing the line losses,

keeping the voltage in acceptable limits according to ANSI Standard C 84.2 and enhancing the reduced life of control and protection equipment such as capacitor banks and OLTCs due to switching losses.

In the literature to date only limited aspects of Volt/VAr optimization have been considered such as optimal capacitor placement using GA in DIGSLIENT [1]. A technique for energy saving through Volt/VAr

* Centre of Energy Research & Development, University of Engineering & Technology, Lahore.

** Department of Electrical Engineering, University of Engineering & Technology, Lahore.

optimization using binary particle swarm optimization is proposed in [1-2]. Optimal reactive power dispatch using PSO (Particle Swarm Optimization) was discussed in [3]. A mixed integer linear programming approach has been implemented with embedded generation in [4-5] suggests an approach of dynamic adjustment of OLTC using DG with reactive power support for voltage profile improvement. A couple of methodologies have been explained using dynamic programming and fuzzy logic controllers where the system is divided into two parts such as substation capacitor and feeder capacitors. Optimal dispatch schedule is calculated by using dynamic programming for both substation and feeder capacitor banks [2]. In [6] some methods are considered using NLP (Nonlinear Programming) to find optimal number of switching operations and applied on PG&E 69 bus system but without considering effects of DG. Dynamic programming does substation control and feeder level control of devices by using fuzzy logic controller. Both parts of system coordinate but the search space size and computational efficiency lays back. These techniques are not expedient for large power systems [7-8]. Some techniques consider the communication system layers and large number of sensing and monitoring devices, which are not part of system [9]. Some commercial solutions such as IVVC (Integrated Volt/VAr Control) are implemented in [3]. In some systems decisions are made on comparative cost of switching and line losses [7,4]. Some other techniques of NLP are used such as dynamic programming, supervised learning [5] and other sensitivity based calculations [6]. In these studies, effects such as optimal number of switching operations in presence of DGs and constraints are less explored while maintaining Volt/VAr standards. Evolutionary algorithms are most important consideration for combinations of Volt/VAr control and optimal switching schedule in presence of DG. Focus of

this paper is to inspect effects of DG on switching states of control devices while considering Volt/VAr standards.

In this paper an optimization technique, GA has been implemented with medium level of DG penetration and 24 hour changing load profiles in MATLAB. This problem is programmed using MATPOWER toolbox and optimization toolbox in MATLAB and outcomes are explained.

2. PROBLEM FORMULATION

This paper intends to develop a Volt/VAr optimization method for optimal dispatch of control variable while working within constraints. Volt/VAr control of control devices which form mixed integer NLP scenarios, because capacitors and tap changers form combinations of continuous and discrete decision variables [7]. In phases of designing and planning, losses of the system are important concerns. In actual scenarios, losses are unavoidable in the system but percentages vary in different designs and conditions. The main objective of Volt/VAr control is loss minimization, which can be done by controlling voltages within permissible limits, because lower voltages cause high currents which can cause high losses.

A 30 bus RDS (Radial Distribution System) is used for purpose of experimentation with 24 hour changing load profiles and DG data. Medium levels of DG penetration are useful therefore, DG penetration level has been kept at 45% [8-9]. Two different types of DGs, wind and solar are considered. Main justification behind integration of DGs in system on load side is to reduce losses caused by overhead lines and underground lines therefore DGs are modeled according to loads connected. Mathematical integration of DG in system is done as:

$$P_{TOTAL} = P_{LOAD} - P_{DG} \quad (1)$$

$$Q_{TOTAL} = Q_{LOAD} - Q_{DG} \quad (2)$$

DG is added in fraction because if DGs are modeled according to 100% load it can cause many fluctuations under variable conditions. P_{DG} is the power inserted by DGs, P_{LOAD} is the power consumed by the load and x is the percentage of penetration.

$$\sum_{i=1}^n P_{DG} = x \sum_{i=1}^m P_{LOAD} \quad (3)$$

Objective function has been formulated mathematically as:

$$X = \min \sum_{k=1}^n P_{loss} = k = 1,2,3, \dots, n \quad (4)$$

$$\min I^2R = \sum_{i=1}^n P \times \left[\frac{p^2 + q^2}{|V^2|} \right] \quad (5)$$

P_{LOSS} is active power loss at buses during each hour. For smooth working of all systems it is necessary that voltage should be in specified limits by ANSI Standard C 84.2 (0.95-1.05 pu). V_i minimum and V_i maximum are voltages of system respectively.

$$V_i, \min \leq V_i \leq V_i, \max \quad (6)$$

Switching constraints defined for control system are number of capacitor banks and OLTC switching which are stated in these Equations (7-8). $NCAP_i$ is number of capacitor bank switching and Tk is number of tap changes in specified time. A control vector U is defined as set of both constraints.

$$NCAP_i \leq NCAP_i, \max \quad (7)$$

$$U = [CAP_i, Tk] \quad (8)$$

3. OPTIMIZATION PROBLEM FORMULATION

MINLP (Mixed Integer Nonlinear Problem) are formulated by continuous, discrete states of control equipment, nonlinear objective functions and constraints. Control devices such as OLTCs and capacitors in VVC of distribution system formulate MINLP optimization problem. Most of engineering research areas have to handle MINLP. Evolutionary algorithms such as GA are very suitable for solving this type of problems [10-11]. An MINLP has the following form of equations:

$$\begin{aligned} &\min f(x) \\ &\text{subject to } AX \leq b \\ &Aeq X = beg \\ &Lb \leq x \leq Ub \\ &Ceq(x) \leq deq \\ &C(x) \leq d \\ &Xi \in Z \end{aligned} \quad (9)$$

Where f is a scalar function having the nonlinear objective function, which is dependent on the following constraints such as: A is a pxn sparse matrix, b is a $px1$ vector. Aeq is a gxn sparse matrix. Beq is a $gx1$ vector. LB and Ub are $nx1$ vectors of upper and lower bounds. C is vector of functions containing nonlinear inequality constraints. Ceq is vector of functions consisting of nonlinear equality constraints. x_i are decision variables which are integer number. x_j are decision variables which are binary numbers, where $i \neq j$. Genetic algorithms are best used for mixed integer nonlinear programming [12-13]. These evolutionary algorithms are best used when problem solving is required through natural selection, whether the problems are mathematical like scheduling and graph coloring or more complex tangible engineering issues such as pipeline flow control, pattern recognition, classification and structural optimization. GA use random search methods therefore it is best for optimization issues

[13]. GA is proposed in this study rather than any other optimization technique because GA is a direct search method. It provides natural selection solution, eliminates the weak candidates from solutions through crossover and provides a high quality solution. GA is also better than other techniques such as PSO for combinatorial problems as PSO shows poor performance in combinatorial scenarios. They are less inclined to getting 'caught' at local optima than gradient search methods. GA is modeled by using genotype which are a set of potential solutions for which genetic algorithm is searching. These are some basic parameters of GA:

3.1 Initial Population

Initial population is randomly created and size of array of chromosome for 24 hour is defined and shown as:

There are two main issues while using GA for MINLP: encoding of continuous variables and efficient constraint handling. MINLP are nonlinear and mixed sort of problem therefore, it is necessary, while using GAs to solve it differently according to problem under considerations. For handling of MINLP while using GAs, a mixed real-discrete coding is used which is superior to many other techniques. Constraint handling is another important issue with GA, which can be solved using tournament selection methods. This selection method chooses individuals from population, a tournament is played among these solutions and best one wins [7,11,14,15].

GA requires encoding of variables which are decision variables and the variables are encoded in form of bits. For example, capacitors have only binary states [0,1] but tap changing transformers have different positions such as [-8,+8] therefore, encoding of tap changer transformer is done as [4]:

$$\text{Transfer Tap} = 1 + 0.0125 \times T_k \tag{10}$$

T_k is number of taps of transformer. Upper and lower bounds of variable are defined for system. In Fig. 1, length of chromosome for capacitors and OLTC pattern for ON/OFF is explained and each capacitor and OLTC will have 24 bits starting from capacitor 1 and so on.

3.2 Mutation

In this process, chromosome bits are randomly changed to make chromosome a best candidate solution.

3.3 Elitism

This is an optional parameter of algorithm in which best candidates are copied to next generation as it is.

3.4 Crossover

This is a convergence process, which tries to converge system's solution, and alters the chromosome code from one to next generation.

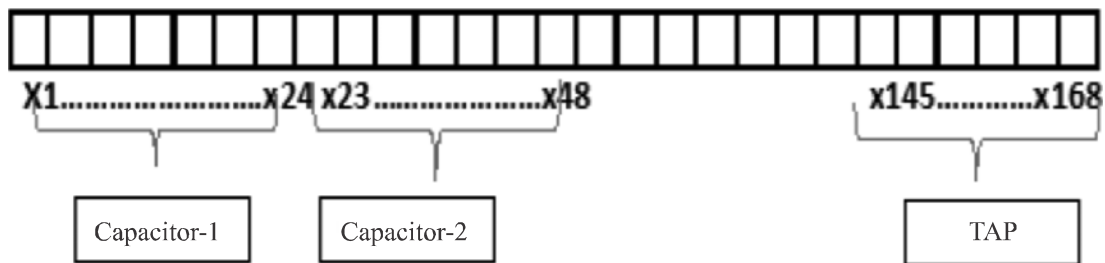

FIG. 1. GENETIC ALGORITHM'S CHROMOSOME LENGTH AND VARIABLE SPECIFICATION

3.5 Fitness Function

This step of algorithm helps to evaluate quality of chromosome and evaluates all potential solutions from all proposed solutions. These are some basic parameters of GA and GA optimization problems formulated are according to [16].

Newton-Raphson method is used for formation of objective function and buses with lowest voltages are used to make objective function. To calculate objective function in algorithm we use MATPOWER commands which use Newton’s method for running AC power flow [17]. Fig. 2 is functional diagram of system working and provides a clear idea about of the system inputs and outputs. Fig. 3 explains the flow of optimization algorithm. In the first step, GA is initialized and GA parameters are defined. In second step, data of the distribution system such as capacitors, tap changers and DGs is defined. Evaluation of each chromosome is done on fitness function and then it considers constraints defined for system. GAs stopping criteria is defined in form of switching constraints and voltage profile limitations. All evolutionary algorithms require work on principle of natural selection and do not converge until stopping

criteria is defined properly. Constraint handling is crucial feature of a constrained optimization problem. Fitness function are used to check quality of individuals from the wholepopulation. To properly handle constraints it is necessary to design fitness function carefully to produce optimized and feasible solution [13,18].

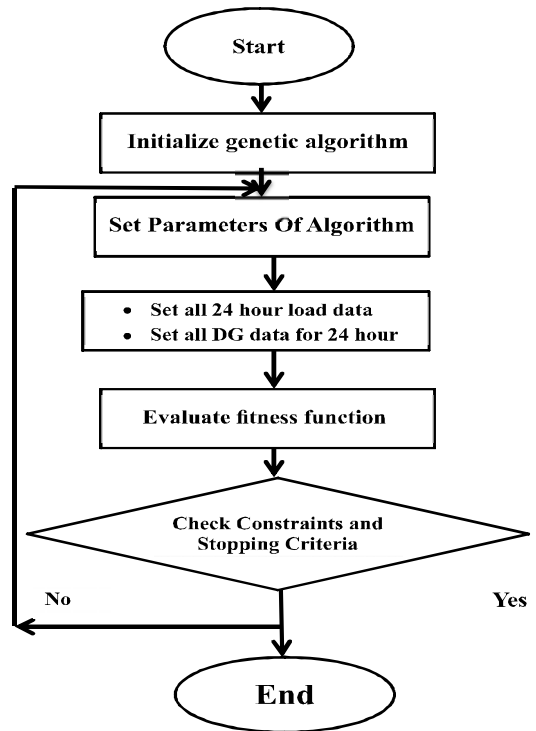

FIG. 3. GENETIC ALGORITHM FLOW CHART

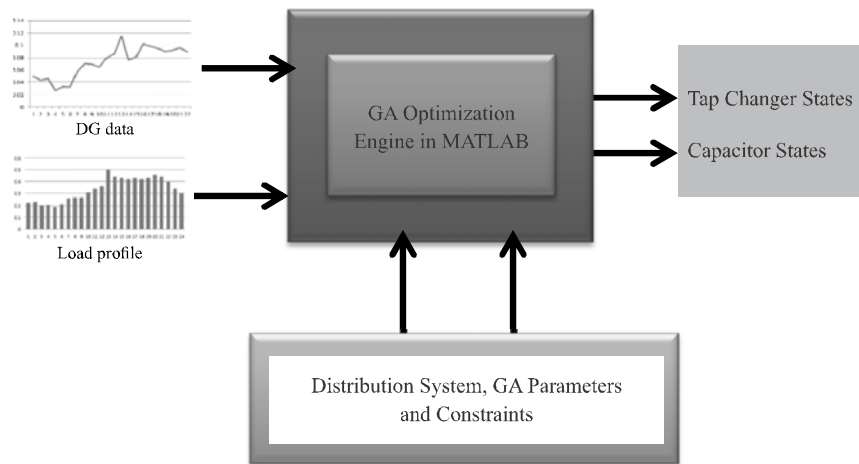

FIG. 2. FUNCTIONAL DIAGRAM OF GA OPTIMIZED METHOD

4. DISTRIBUTION SYSTEM

The test distribution system used to apply proposed algorithm is a 30 bus distribution system. This is composed of one generator at bus 1, 2 photovoltaic DGs and four wind DGs. This system has six capacitors and one tap changer transformer for applying control scheme, shown in Fig. 4. On load tap changer is placed between bus 1 and bus 2 and positions of capacitors along with rated values are explained in Table 1. In this system penetration, level of DG is kept 45%. Wind and PV data for 24 hour is shown in Figs. 5-6, these graphs show 45% penetration of DGs at bus number 11, 18, 21, 24 and 28 according to the load attached at these positions [19]. This data is calculated according to Equations (1-3). For purpose of Volt/VAr control there are six capacitors used on different buses and the values of capacitors are specified in Table 1.

For purpose of analysis and simulations, IEEE 30 bus modified system is analyzed over a 24 hours period with time lengths of 1h i.e. 24 steps in a day. This distribution system is designed in MATLAB using MATPOWER tool for solving power flows under different conditions and GA is as the optimization technique to dispatch an optimal schedule.

5. SIMULATION RESULTS

Simulation results of the proposed technique are explained in this section. In this study, we compare results achieved from Volt/VAr optimization technique in distribution system, therefore, 30 bus modified IEEE power distribution system is selected. Results are compared on basis of losses, voltage profile improvement and optimal control

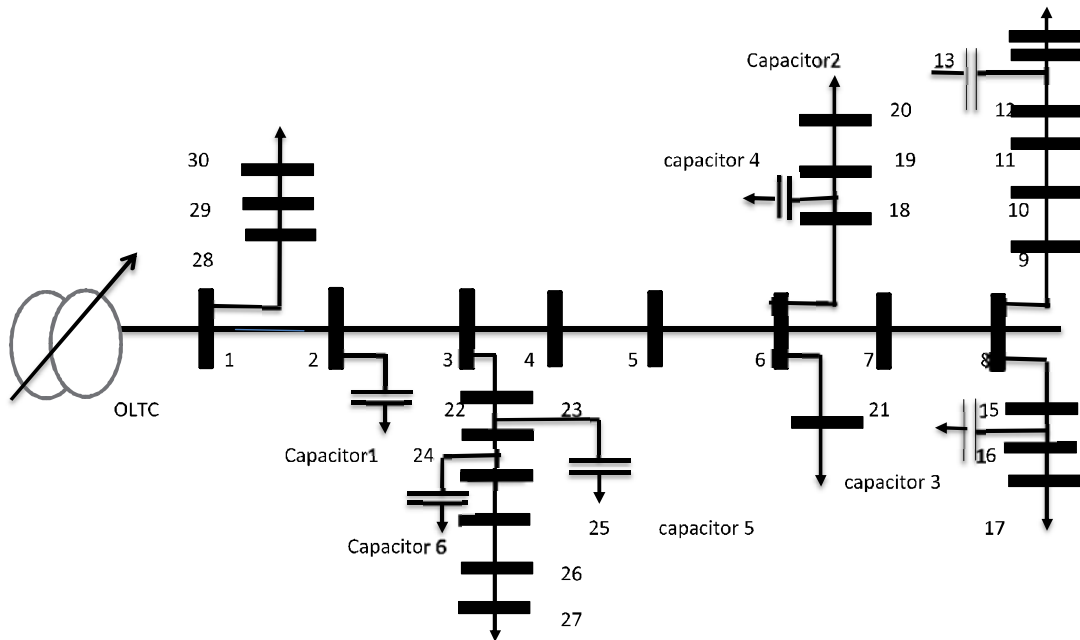

FIG. 4. 30 BUS DISTRIBUTION SYSTEM [16]

TABLE 1. CAPACITOR DATA OF SYSTEM

Capacitors	C1	C2	C3	C4	C5	C6
Bus No.	2	13	15	23	19	25
KVAR	600	600	300	900	900	900

variable scheduling with and without the impact of DGs. Optimization solution is proposed using GA. When optimal power flow with N-R method is used on IEEE-30 bus system its lowest voltage is 0.883 pu. Fig. 7 is comparison of voltage profile improvement scenarios with no control and GA optimized system, shows improvement of 0.883-0.951 pu. in the system. Similarly Fig. 8 is comparison of voltage profile improvement scenarios with

GA optimized and GA implementation with distributed generation in the system, shows improvement of 0.951-0.965 pu in the system

Figs. 9-10 shows that active and reactive power loss profiles of system has been improved as result of implementation of optimization algorithm. A total of active and reactive power loss reduction, is achieved when GA is applied in combination of distributed generation.

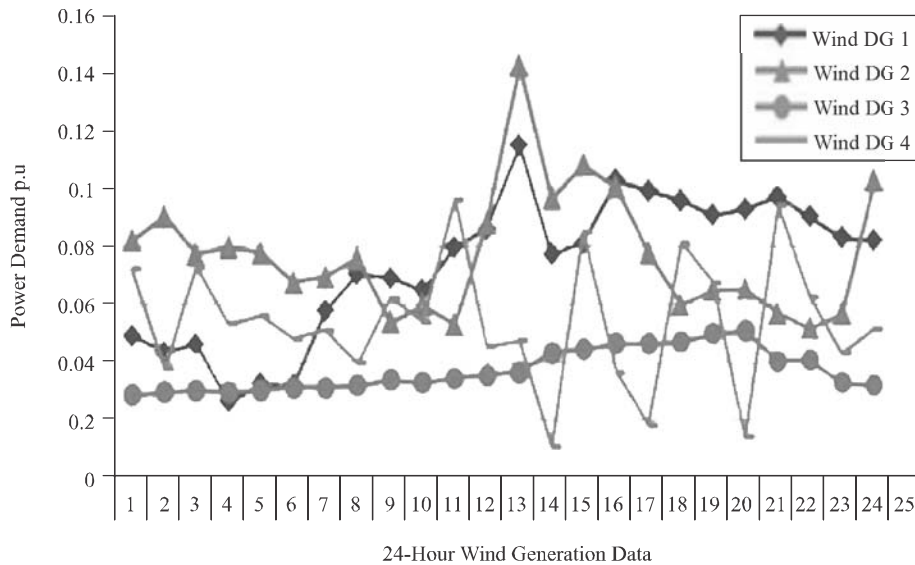

FIG. 5. 24 HOUR WINDDATA [19]

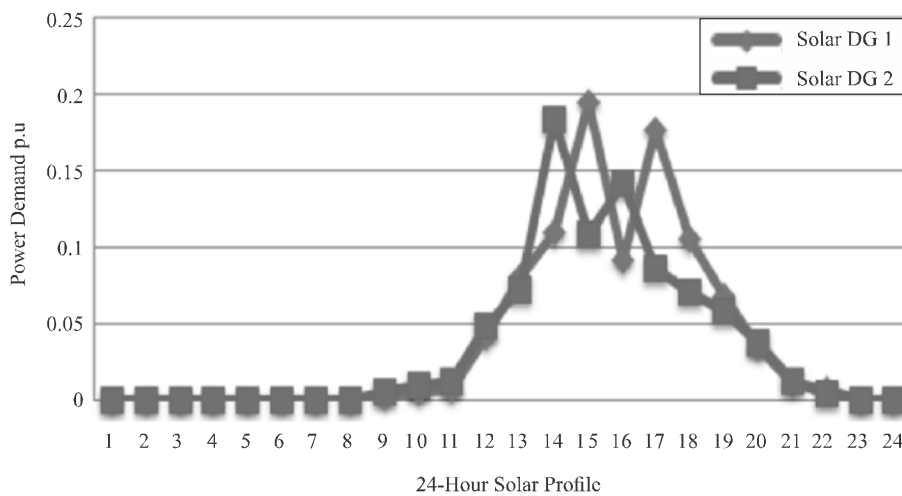

FIG. 6. 24-HOUR SOLAR DATA [19]

In phases of designing and planning, losses are important discussions in system. In actual scenarios, losses are unavoidable in system but percentages vary

in different designs and conditions. Fig. 11 is illustration of fact that approximately 50% of losses have been reduced.

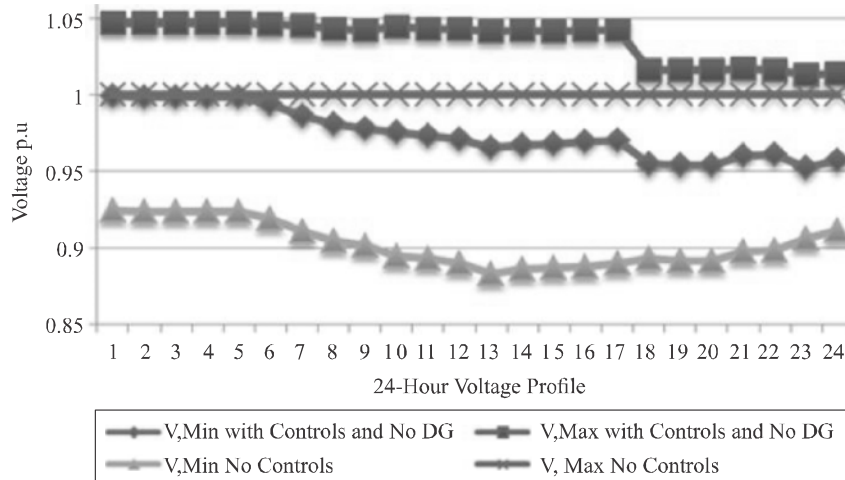

FIG. 7. VOLTAGE PROFILE OF PRE CONTROL AND GA OPTIMIZED SYSTEM

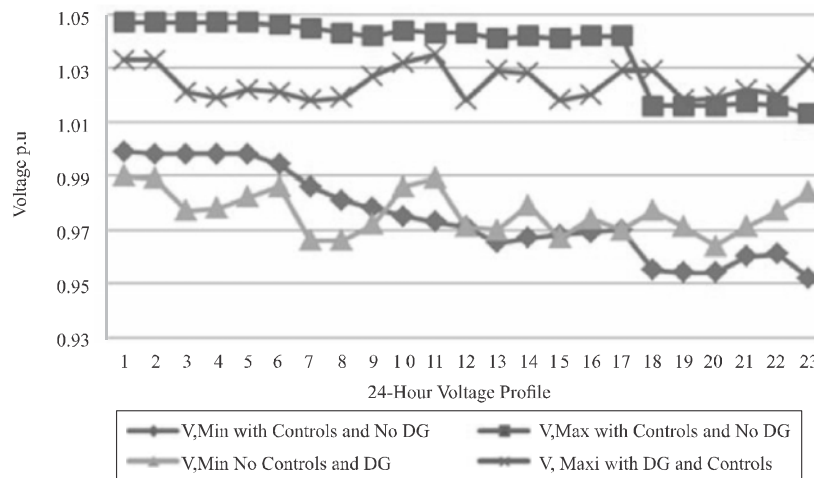

FIG. 8. VOLTAGE PROFILE WITH DG AND CONTROL

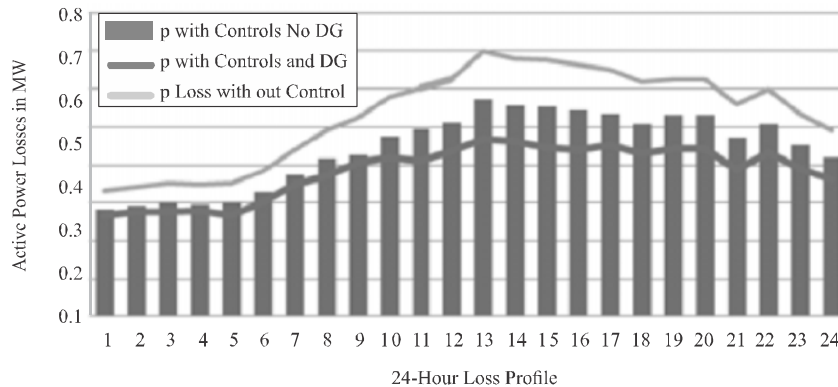

FIG. 9. ACTIVE POWER LOSS PROFILE

Table 2 is optimal dispatch schedule of capacitors and OLTC without DG and it has very small number of switching transitions for duration of a day. Table 3 is narration of effects of DG on switching schedule of devices but results are within constraints and losses are improved. According to loads and DG characteristics after every hour, status of capacitors and tap changers will be updated. Switching constraints defined for capacitors are

eight and for tap changers are 14 for per day length of time and total transitions are quantified in end of Tables 2-3. It is observed from the switching optimization schedules that more number of transitions has occurred in day timing when DG penetrations are maximum. Loss curtailments are also high in this duration due to more transitions and distributed generations. The proposed technique provides promising solution with in constraints.

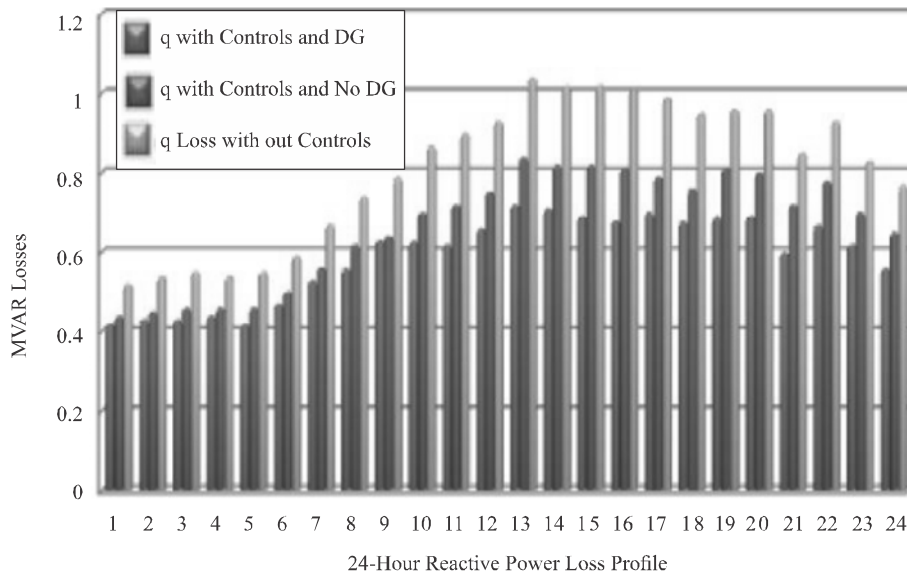

FIG. 10. REACTIVE POWER LOSS PROFILE

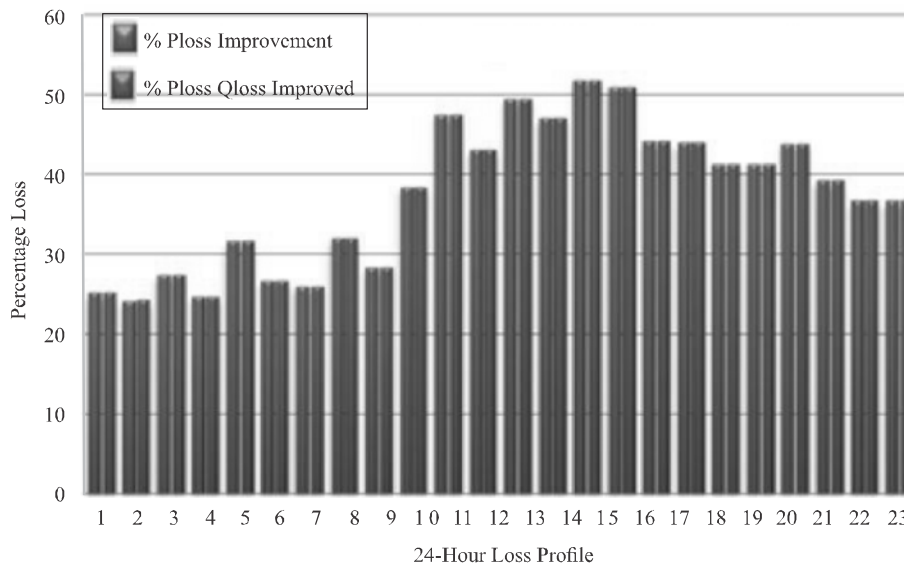

FIG. 11. PERCENTAGE LOSS IMPROVEMENTS

TABLE 2. OPTIMAL DISPATCH SCHEDULE OF CONTROL STATES WITHOUT DG

Hour	C1	C2	C3	C4	C5	C6	OLTC
1	600	0	0	0	0	0	0.9375
2	600	0	0	0	0	0	0.9375
3	600	0	0	0	0	0	0.9375
4	600	0	0	0	0	0	0.9375
5	600	0	0	0	0	0	0.9375
6	600	0	0	0	0	0	0.9375
7	600	0	0	0	0	0	0.9375
8	600	0	0	0	0	0	0.9375
9	600	0	0	0	0	0	0.9375
10	600	0	0	0	300	0	0.9375
11	600	0	0	0	300	0	0.9375
12	600	0	0	0	300	0	0.9375
13	600	0	0	0	300	0	0.9375
14	600	0	0	0	300	0	0.9375
15	600	0	0	0	300	0	0.9375
16	600	0	0	0	300	0	0.9375
17	600	0	0	0	300	0	0.9375
18	600	0	0	0	300	0	0.9625
19	600	0	0	0	300	0	0.9625
20	600	0	0	0	300	0	0.9625
21	600	0	0	0	300	0	0.9625
22	600	0	0	0	0	0	0.9625
23	600	0	0	0	0	0	0.9625
24	600	0	0	0	0	0	0.9625
Total	0	0	0	0	2	0	1

TABLE 3. OPTIMAL DISPATCH SCHEDULE OF CONTROL STATES WITH DG

Hour	C1	C2	C3	C4	C5	C6	Tap
1	600	600	0	900	0	0	0.95
2	600	600	0	0	0	0	0.9625
3	600	600	0	900	0	900	0.9625
4	0	600	300	900	0	900	0.9625
5	0	600	300	0	0	900	0.95
6	0	0	300	900	0	900	0.95
7	0	0	0	900	900	900	0.9625
8	600	0	0	900	900	0	0.9625
9	600	0	0	900	900	0	0.9625
10	600	600	300	900	0	0	0.9625
11	0	600	300	0	900	900	0.95
12	0	600	300	0	0	900	0.95
13	0	0	300	0	0	900	0.9625
14	0	600	300	900	0	0	0.95
15	600	600	0	0	900	900	0.95
16	0	0	300	900	0	900	0.95
17	0	600	0	0	900	0	0.95
18	0	600	0	900	0	900	0.9625
19	600	600	300	0	900	0	0.95
20	600	0	300	0	900	900	0.95
21	600	0	300	900	900	900	0.9625
22	600	600	300	900	900	900	0.9625
23	0	0	300	0	0	900	0.9625
24	0	600	300	0	900	900	0.9625
Total	5	7	7	8	7	6	7

6. CONCLUSION

This proposed method is an efficient technique for improvement of switching losses and voltage profile in the presence of DGs of different types because DGs produce fluctuations in the system due to their variable nature. Proposed technique is not violating system

constraints under any operating conditions. Basic provocation behind this method is to quantify and optimize the effects on control variables caused by DG. Proposed algorithm is based on an optimization technique, which is a search method but provides efficient solution for real application on distribution system.

ACKNOWLEDGEMENTS

Author would like to thank all supervisors and reviewers for their continuous support and constructive critique during research. Author would also like to thank her institute University of Engineering & Technology, Lahore, Pakistan, for providing her this research opportunity.

REFERENCES

- [1] Devriese, G., Shariatzadeh, F., and Srivastava, A.K., "Volt/VAr Optimization with Energy Savings for Distribution System using Intelligent Control", North American Power Symposium, pp. 1-6, Manhattan, KS, USA, 2013.
- [2] Genc, M.J.K.A.S. "A Coordinated Optimization Approach to Volt/VAr Control for Large Power Distribution Networks", O'Farrell Street, San Francisco, CA, USA, 29th June - 1st July, 2011.
- [3] McFetridge, B., and Stephens, B., "Can a Grid be Smart without Communications? A Look at IVVC Implementation", IEEE Conference on Rural Electric Power, pp. A2-1-A2-21, Stone Mountain, GA,US, 2013.
- [4] Liu, Y., Zhang, P., and Qiu, X., "Optimal Volt/Var Control in Distribution Systems", International Journal of Electrical Power & Energy Systems, Volume 24, No. 5, pp. 271-276, 2002.
- [5] Villacci, D., Bontempi, G., and Vaccaro, V., "An Adaptive Local Learning-Based Methodology for Voltage Regulation in Distribution Networks with Dispersed Generation", IEEE Transactions on Power Systems, Volume 21, pp. 1131-1140, 2006.
- [6] Pilo, F., Pisano, G., and Soma, G.G., "Optimal Coordination of Energy Resources with a Two-Stage Online Active Management", IEEE Transactions on Industrial Electronics, Volume 58, pp. 4526-4537, 2011.
- [7] Paaso, E.A., Liao, Y., and Cramer, A.M., "Formulation and Solution of Distribution System Voltage and VAR Control with Distributed Generation as a Mixed Integer Nonlinear Programming Problem", Electric Power Systems Research, Volume 108, pp. 164-169, 2014.
- [8] Jiang, F., Zhang, Z., Cao, T., Hu, B., and Piao, Z., "Impact of Distributed Generation on Voltage Profile and Losses of Distribution Systems", 32nd Chinese Conference on Control, pp. 8587-8591, Xian, China, 2013 .
- [9] Balamurugan, K., Srinivasan, D., and Reindl, T., "Impact of Distributed Generation on Power Distribution Systems", Energy Procedia, Volume 25, pp. 93-100, 2012.
- [10] Young, C.-T. Zheng, Y., Yeh, C.-W., and Jang, S.-S. "Information-Guided Genetic Algorithm Approach to the Solution of MINLP Problems", Industrial & Engineering Chemistry Research, Volume 46, pp. 1527-1537, 2007.
- [11] Costa, L., and Oliveira, P., "Evolutionary Algorithms Approach to the Solution of Mixed Integer Nonlinear Programming Problems", Computers & Chemical Engineering, Volume 25, pp. 257-266, 2001.
- [12] Michalewicz, P.S.Z., and Pibouleau, P.S.D.L., "Some Guidelines for Genetic Algorithm Implementation in MINLP Batch Plant Design Problems", Advances in Metaheuristics for Hard Optimization, Springer Berlin Heidelberg, pp. 295-315, France, 2013.
- [13] Man, K.F., Tang, K.S., and Kwong, S., "Genetic Algorithms: Concepts and Applications [Engineering Design]", IEEE Transactions on Industrial Electronics, Volume 43, pp. 519-534, 1996.
- [14] Yin-Xiu, L., and Gen, M., "Nonlinear Mixed Integer Programming Problems using Genetic Algorithm and Penalty Function", IEEE International Conference on Systems, Man, and Cybernetics, Volume 4, pp. 2677-2682, Beijing, China, 1996.
- [15] Borghetti, A., "Using Mixed Integer Programming for the Volt/Var Optimization in Distribution Feeders", Electric Power Systems Research, Volume 98, pp. 39-50, 2013.
- [16] Abdelsalam, A.A., Zidan, A.A., and El-Saadany, E.F., "Optimal DG Allocation in Radial Distribution Systems with High Penetration of Nonlinear Loads", Electric Power Components and Systems, Volume 43, pp. 1487-1497, 2015.

- [17] Akorede, M.F., and Hizam, H., "Teaching Power System Analysis Courses using MATPOWER", International Conference on Engineering Education, pp. 45-51, Kuala Lumpur, Malaysia, 2009.
- [18] Yokota, T., and Gen, M., "Solving for Nonlinear Integer Programming Problem using Genetic Algorithm and its Application", IEEE International Conference on in Systems, Man, and Cybernetics, Humans, Information and Technology, Volume 2, pp. 1602-1609 ,1994.
- [19] Atwa, Y.M., El-Saadany, E.F., Salama, M.M.A. and Seethapathy, R., "Optimal Renewable Resources Mix for Distribution System Energy Loss Minimization", IEEE Transactions on Power Systems, Volume 25, pp. 360-370, 2010.
- [20] Yue, Y., Kejun, Q., and Chengke, Z., "The Optimal Location and Penetration Level of Distributed Generation", 42nd International Conference, Universities Power Engineering, pp. 917-923, Brighton, England, 2007.